

KMH-2000S_H(3)

HIGH CAPACITY STACKABLE ICE CUBER

Item # _____

Project: _____

Qty: _____

*AutoCad available on KCL

KMH-2000S_H(3)

6/11

Item # 13264

CUBER DIMENSIONS

W x D x H

KMH-2000S_H(3)
36 x 40 x 36^{7/16}



KMH-2000SWH

Water-Cooled 1 Phase

KMH-2000SWH3

Water-Cooled 3 Phase

KMH-2000SRH



Remote Air-Cooled 1 Phase

KMH-2000SRH3

Remote Air-Cooled 3 Phase

Shown on a Kloppenberg 2115
Double Upright Bin

*Please allow for adequate lead time when placing orders

- 40" Depth ice machine frame
- Up to 1944 lbs. of ice production per 24 hours
- Stackable for 7776 lbs. per 24 hour ice production in the same floor space
- Durable stainless steel exterior
- Protected by *H-GUARD Plus* Antimicrobial Agent 
- CycleSaver® design 
- EverCheck® alert system 
- Individual crescent cube
- Stainless steel evaporator
- R-404A Refrigerant

* The KMH-2000SRH and KMH-2000SRH3 are ENERGY STAR qualified.

Warranty

Valid in United States, Canada, Puerto Rico, & U.S. Territories. Contact factory for warranty in other countries.

Three Year - Parts & Labor on entire machine.

Five Year - Parts & Labor on: Evaporator.

Five Year - Parts on: Compressor, air-cooled condenser coil.



ISO 9001-15:014901

© HOSHIZAKI AMERICA, INC.

618 Hwy. 74 S., Peachtree City, GA 30269

TEL 1-800-438-6087

FAX 1-800-345-1325

www.hoshizaki.com



KMH-2000S_H(3) HIGH CAPACITY STACKABLE ICE CUBER

DIMENSIONS
W x D x H
KMH-2000S_H(3)
36 x 40 x 36^{7/16}

**Allow 10 1/2" to depth after install for snout/door assembly

STACKABLE ICE CUBER

- Water-cooled 1 phase / Water-cooled 3 phase
- Remote Air-cooled 1 phase / Remote Air-cooled 3 phase

WATER - COOLED 1 PHASE / 3 PHASE

Water Temp ° F.	50°	70°	90°
Air Temp ° F. 70°	1821 / 1861	1803 / 1822	1695 / 1685
80°	1807 / 1832	1780 / 1771	1625 / 1588
90°	1803 / 1822	1760 / 1729	1623 / 1562

REMOTE AIR - COOLED 1 PHASE / 3 PHASE

Water Temp ° F.	50°	70°	90°
Air Temp ° F. 70°	1944 / 1929	1871 / 1855	1740 / 1719
80°	1888 / 1872	1774 / 1757	1626 / 1602
90°	1871 / 1855	1694 / 1675	1550 / 1525

UTILITY CONSUMPTION

Model Number	Ice Production Per Cycle Lbs. Cubes	KWH per 100 LBS.	Potable Water Gal. per 100 lbs.	Condenser Water Gal. per 100 lbs.
KMH-2000SWH	45.4 2160	3.30	17.5	84
KMH-2000SWH3	48.1 2160	3.20	17.1	79
KMH-2000SRH	47.7 2160	3.80	18.1	N/A
KMH-2000SRH3	46.9 2160	3.70	16.8	N/A

SPECIFICATIONS

Model Number	Condenser	Amperage	Min. Circuit Ampacity	Shipping Weight
KMH-2000SWH	Water-Cooled	12.1	30	415 lbs.
KMH-2000SWH3	Water-Cooled	7.7	20	415 lbs.
KMH-2000SRH	Remote Air-Cooled	14.9	30	415 lbs.
KMH-2000SRH3	Remote Air-Cooled	9.9	20	415 lbs.

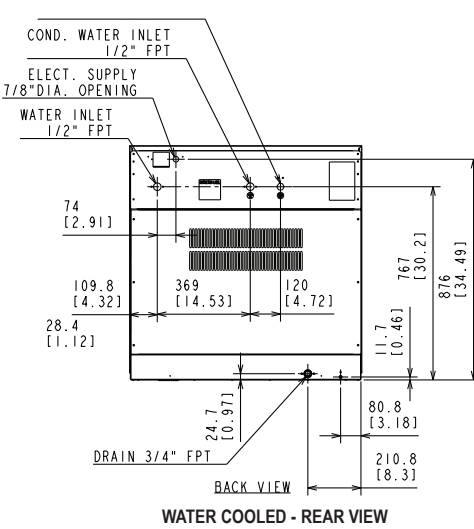
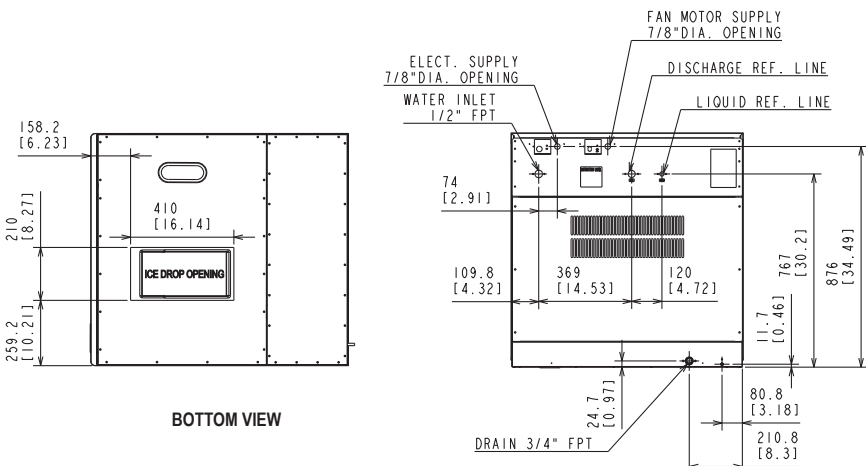
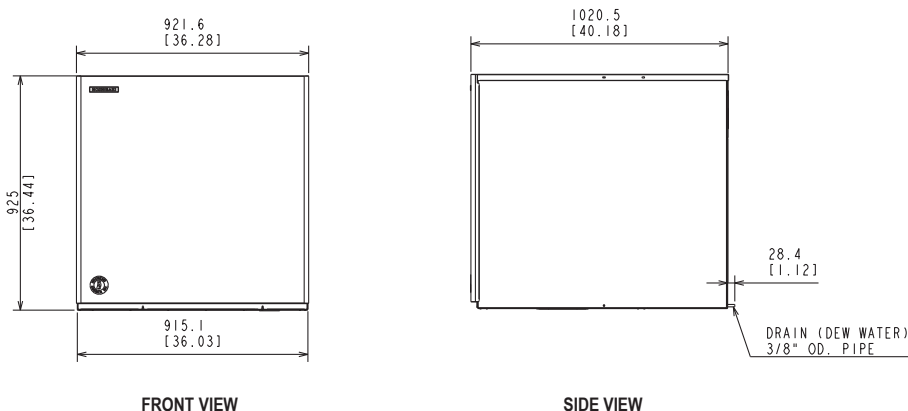

URC-22F Remote Condenser (Sold Separately)
For Use with KMH-2000SRH & KMH-2000SRH3

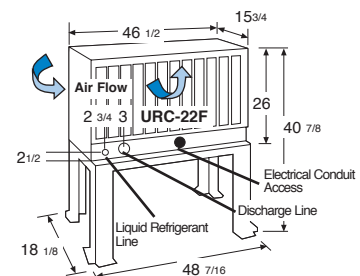

Voltage supply for the URC Remote Condenser is supplied from the Ice Maker. No additional circuit is required.

Pre-Charged Tubing Kits (Sold Separately)
20' R404A-20610-2
35' R404A-35610-2
55' R404A-55610-2

ELECTRICAL & PLUMBING / KMH-2000S_H(3)

- KMH-2000SWH / SRH
- 208 - 230V/60/1Ø (3 wire with neutral for 115V)
 - 30 amp Max Fuse/HACR Breaker Size
- KMH-2000SWH3 / SRH3
- 208 - 230V/60/3Ø
 - 20 amp Max Fuse/HACR Breaker Size
- KMH-2000S_H(3)
- 1/2" FPT copper or equivalent independent potable water supply
 - 3/4" FPT independent drain connection

OPERATING LIMITS

- Ambient Temp Range 45 - 100°F
- Water Temp Range 45 - 90°F
- Water Pressure 10 - 113psig
- Voltage Range 187 - 253V

SERVICE

- Panels easily removed and all components accessible for service.

CONDENSING UNIT

- Voltage Range 104 - 127V
- Ambient Temp Range -20 - 122°F

