

KMD-850M_H

MODULAR CRESCENT CUBER

Item # _____

Project: _____

Qty: _____

*AutoCad available on KCL

KMD-850M_H

I/13

Item # 13230

CUBER DIMENSIONS

W x D x H

KMD-850M_H
30 x 24^{5/8} x 28



KMD-850MAH

Air-Cooled

KMD-850MWH

Water-Cooled

KMD-850MRH

Remote Air-Cooled
Shown on an optional
Lancer 30" Dispenser

- Up to 836 lbs. of ice production per 24 hours
- Ice on beverage design
- Durable stainless steel exterior
- Individual crescent cube
- Protected by H-GUARD Plus Antimicrobial Agent
- CycleSaver® Design
- EverCheck® alert system
- Stainless steel evaporator
- Removable air filters (Air-cooled model only)
- R-404A Refrigerant



ISO 9001:2015

Warranty

Valid in United States, Canada, Puerto Rico, & U.S. Territories. Contact factory for warranty in other countries.

Three Year - Parts & Labor on entire machine.

Five Year - Parts & Labor on: Evaporator.

Five Year - Parts on: Compressor, air-cooled condenser coil.



HOSHIZAKI

KMD-850M_H MODULAR CRESCENT CUBER

DIMENSIONS
W x D x H
KMD-850M_H
30 x 24^{5/8} x 28

- Air-cooled
- Water-cooled
- Remote Air-cooled

AIR-COOLED

Water Temp ° F.	50°	70°	90°
Air Temp ° F.	70°	743	685
80°	753	686	629
90°	743	639	580

WATER-COOLED

Water Temp ° F.	50°	70°	90°
Air Temp ° F.	70°	836	830
80°	831	822	759
90°	830	815	759

REMOTE AIR-COOLED

Water Temp ° F.	50°	70°	90°
Air Temp ° F.	70°	833	791
80°	801	737	686
90°	791	691	638

UTILITY CONSUMPTION

Model Number	Ice Production Per Cycle		KWH per 100 LBS. 90/70	Potable Water Gal. per 100 lbs. 90/70	Condenser Water Gal. per 100 lbs. 90/70
	Lbs.	Cubes			
KMD-850MAH	11.8	624	5.9	19.5	N/A
KMD-850MWH	12.1	624	4.1	20.2	127
KMD-850MRH	11.6	624	5.4	19.5	N/A

SPECIFICATIONS

Model Number	Condenser	Amperage	Min. Circuit Ampacity	Shipping Weight
KMD-850MAH	Air-Cooled	9.8	20	249 lbs.
KMD-850MWH	Water-Cooled	8.3	20	249 lbs.
KMD-850MRH	Remote Air-Cooled	9.8	20	235 lbs.

KM CUBE DIMENSIONS

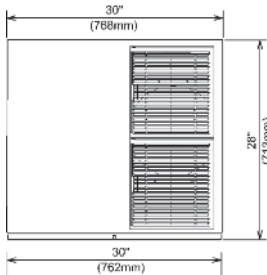
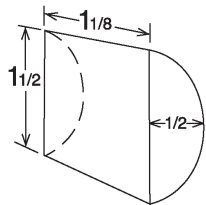

**KMD-850MAH
FRONT VIEW**

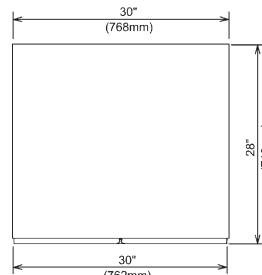

**KMD-850MRH & MWH
FRONT VIEW**

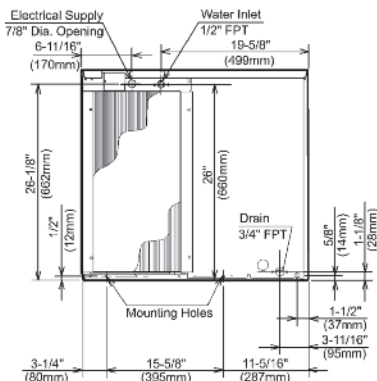

AIR-COOLED UNIT

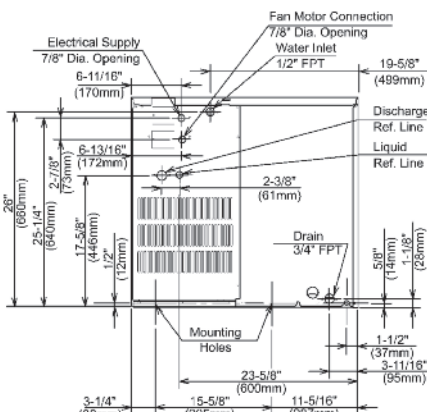

REMOTE AIR-COOLED UNIT

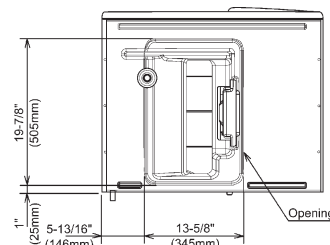

ICE DROP ZONE

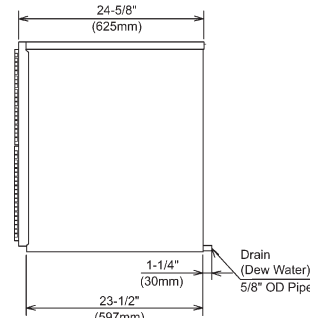

SIDE VIEW

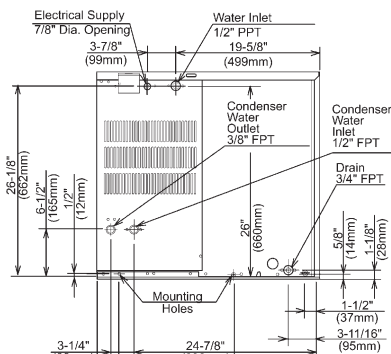

WATER-COOLED UNIT

URC-9F Remote Condenser (Sold Separately)
For Use with KMD-850MRH

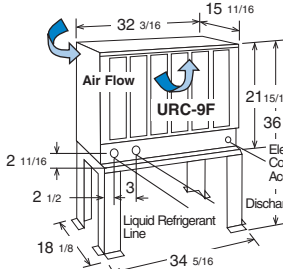

Voltage supply for the URC Remote Condenser is supplied from the Ice Maker. No additional circuit is required.



Pre-Charged Tubing Kits
(Sold Separately)
20' R404-2068-2
35' R404-3568-2

ELECTRICAL & PLUMBING/KMD-850M_H

- 208-230V/60/1 (3 wire with dedicated neutral for 115V)
- 20 amp Max Fuse/HACR Breaker Size
- 3/8" OD copper or equivalent independent potable water supply
- 3/4" FPT independent drain connection



© HOSHIZAKI AMERICA, INC.

618 Hwy. 74 S., Peachtree City, GA 30269

OPERATING LIMITS

- Ambient Temp Range 45 - 100°F
- Water Temp Range 45 - 90°F
- Water Pressure 10 - 113psig
- Voltage Range 187 - 253V

CONDENSING UNIT

- Voltage Range 104 - 127V
- Ambient Temp Range -20 - 122°F

SERVICE

- Panels easily removed and all components accessible for service.
- Removable/cleanable air filters. (Air-Cooled model only)

TEL 1-800-438-6087

FAX 1-800-345-1325

www.hoshizaki.com

Printed in U.S.A.

