

F-1001M_H-C

MODULAR CUBELET ICE MACHINE

SLIM-LINE SERIES

Item # _____

Project: _____

Qty: _____

*AutoCad available on KCL

F-1001M_H-C

I/13

Item # 13107

CUBELET DIMENSIONS

W x D x H

F-1001M_H-C
22 x 27^{3/8} x 25^{15/16}



B-300



B-500



B-700

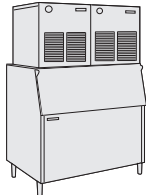

B-800

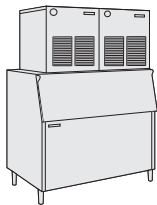

B-900

Also available on Large Bins:
B-1150SS
B-1300SS
B-1500SS
B-1650SS

CUBELET DIMENSIONS

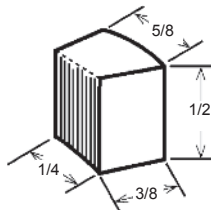

F-1001MAH-C

Air-Cooled

Shown on an optional
B-700

F-1001MWH-C

Water-Cooled

F-1001MRH-C

Remote Air-Cooled

- Up to 910 lbs. of ice production per 24 hours
- Durable stainless steel exterior
- CleanCycle I2® Design 
- 15 minute flush cycle every 12 hours
- Removes sediment
- Cleaner ice
- Longer life and easy maintenance
- R-404A Refrigerant

* The F-1001MAH-C is ENERGY STAR qualified.



ISO9001-15014:2001

Warranty

Valid in United States, Canada, Puerto Rico, & U.S. Territories. Contact factory for warranty in other countries.

Three Year - Parts & Labor on entire machine. (Serial numbers Vxxxxx) and after.)

Five Year - Parts on Compressor, air-cooled condenser coil.



HOSHIZAKI

F-100IM_H-C CUBELET ICE MACHINE SLIM-LINE MODULAR SERIES

DIMENSIONS
W x D x H
F-100IM_H-C
22 x 27^{3/8} x 25^{15/16}

- Air-cooled
- Water-cooled
- Remote Air-cooled

AIR-COOLED

Water Temp° F.	50°	70°	90°
Air Temp° F. 70°	910	860	830
Air Temp° F. 80°	800	770	740
Air Temp° F. 90°	630	680	660

WATER-COOLED

Water Temp° F.	50°	70°	90°
Air Temp° F. 70°	790	760	750
Air Temp° F. 80°	735	720	710
Air Temp° F. 90°	695	685	670

REMOTE AIR-COOLED

Water Temp° F.	50°	70°	90°
Air Temp° F. 70°	840	810	790
Air Temp° F. 80°	765	745	720
Air Temp° F. 90°	700	695	660

UTILITY CONSUMPTION

Model Number	KWH per 100 LBS. 90/70	Potable Water Gal. per 100 lbs.
F-1001MAH-C	5.4	12.0
F-1001MWH-C	4.3	12.0
F-1001MRH-C	5.5	12.0

SPECIFICATIONS

Model Number	Condenser	Amperage	Min. Circuit Ampacity	Shipping Weight
F-1001MAH-C	Air-Cooled	8.1	15	205 lbs.
F-1001MWH-C	Water-Cooled	7.2	15	210 lbs.
F-1001MRH-C	Remote Air-Cooled	7.2	15	210 lbs.

STORAGE BINS

Model Number	Application Capacity	ARI-Rated Capacity
B-300	300 lbs.	260 lbs.
B-500	500 lbs.	360 lbs.
B-700	700 lbs.	550 lbs.
B-800	800 lbs.	600 lbs.
B-900	900 lbs.	660 lbs.
B-1150	1150 lbs.	N/A
B-1300	1275 lbs.	N/A
B-1500	1490 lbs.	N/A
B-1650	1605 lbs.	N/A

ELECTRICAL & PLUMBING/F-100IM_H-C

- 208-230V/60/1 (3 wire with dedicated neutral for 115V)
- 3/8" OD copper or equivalent independent potable water supply
- 3/4" FPT independent drain connection



© HOSHIZAKI AMERICA, INC.

618 Hwy. 74 S., Peachtree City, GA 30269

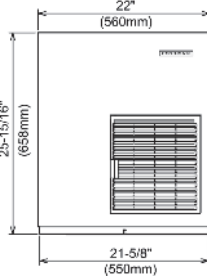

FRONT VIEW

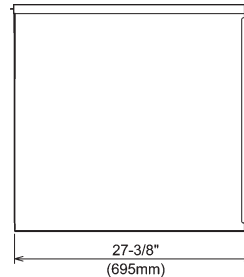

SIDE VIEW

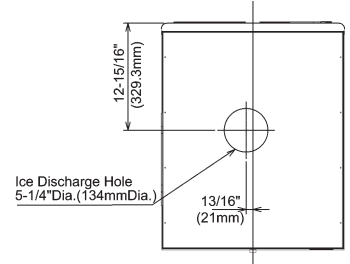

ICE DROP ZONE

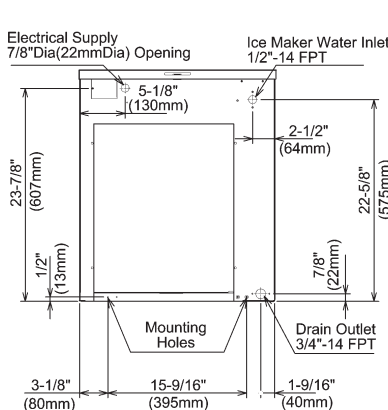

AIR-COOLED UNIT

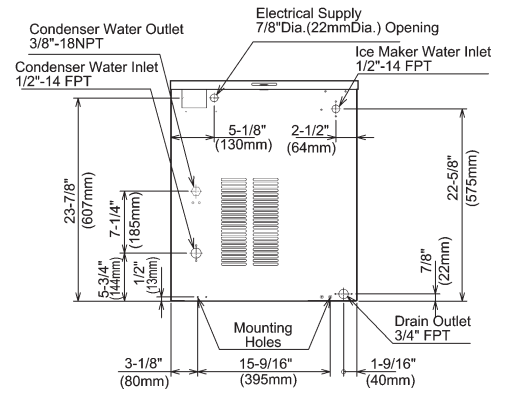

WATER-COOLED UNIT

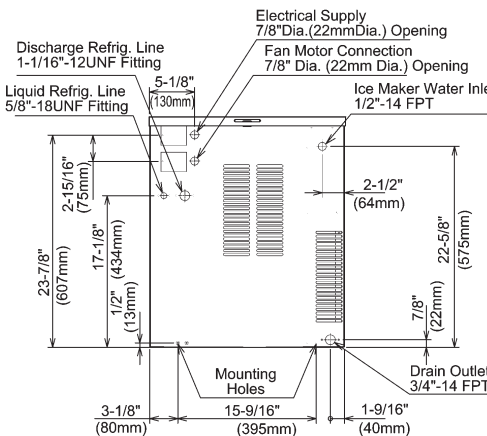

REMOTE AIR-COOLED UNIT

URC-5F Remote Condenser (Sold Separately)
For Use with F-1001MRH-C

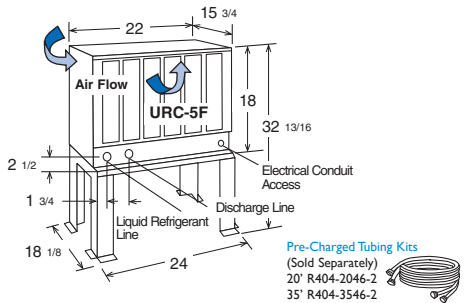

Voltage supply for the URC Remote Condenser is supplied from the Ice Maker. No additional circuit is required.

OPERATING LIMITS

- Ambient Temp Range 45 - 100°F
- Water Temp Range 45 - 90°F
- Water Pressure 10 - 113psig
- Voltage Range 187 - 253V

SERVICE

- Panels easily removed and all components accessible for service.
- Removable/cleanable air filter. (Air-Cooled model only)

